

**IMPORTANTE!**

Min. 42

Max. 78

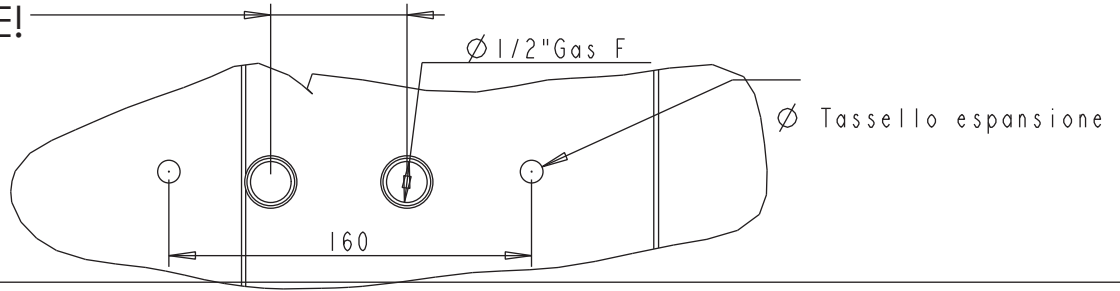

2

Flessibile  
alimentazione  
cascata

Flessibile  
alimentazione  
doccia

Adattatore 1/2" M  
con limitatore  
interno

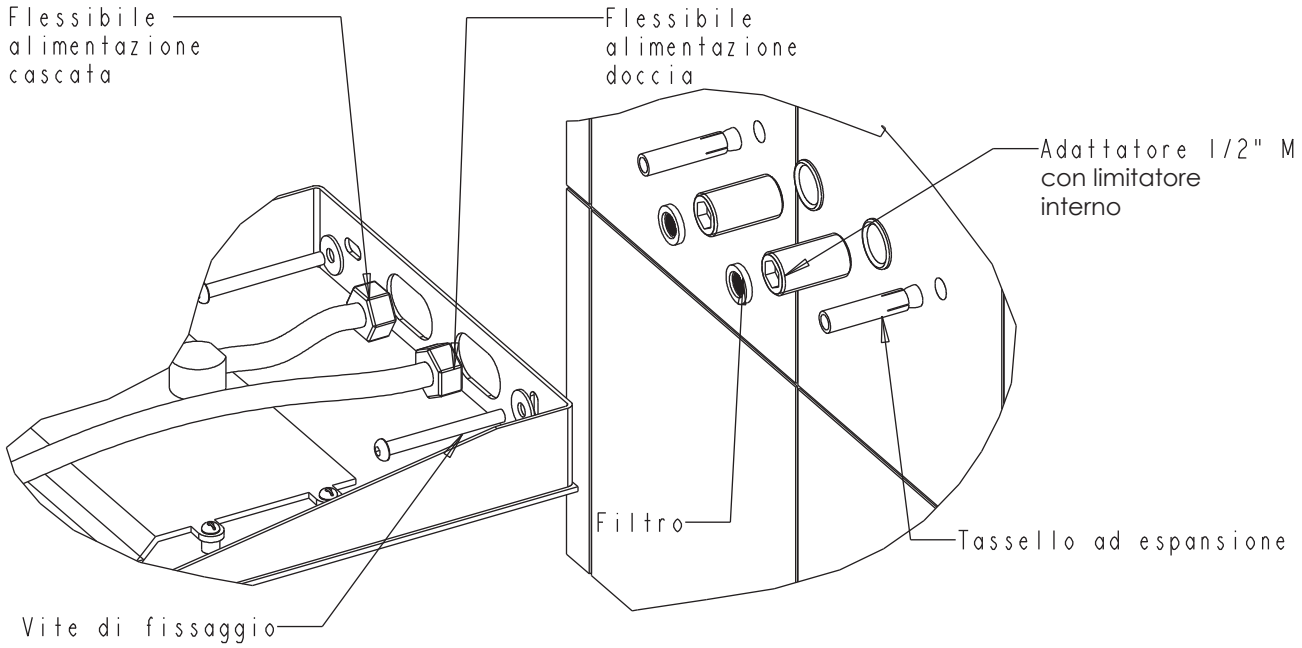

3

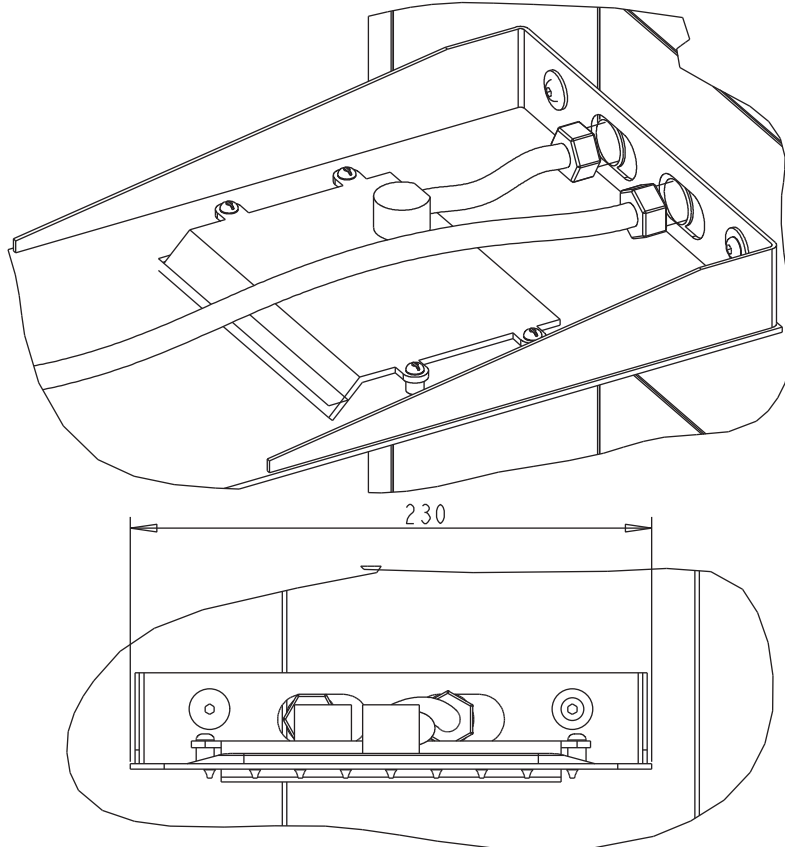













## #ECOGREEN

Come smaltire gli imballaggi  
How to dispose of packaging



<b>SCATOLONE IN CARTONE ONDULATO</b>   CORRUGATED CARDBOARD BOX		CARTA   PAPER
<b>SCATOLONE IN CARTONE NON ONDULATO</b>   NON-CORRUGATED CARDBOARD BOX		CARTA   PAPER
<b>IMBALLAGGI IN CARTA</b>   PAPER PACKAGING		CARTA   PAPER
<b>FOGLIO ISTRUZIONI</b>   INSTRUCTIONS SHEET		CARTA   PAPER
<b>SACCHETTI PLURIBALL</b>   BUBBLE WRAP BAGS		PLASTICA   PLASTIC
<b>SACCHETTI PLASTICA TRASPARENTE</b>   CLEAR PLASTIC BAGS		PLASTICA   PLASTIC
<b>SACCHETTINI ARIA</b>   AIR CUSHIONS		PLASTICA   PLASTIC
<b>IMBALLI IN SPUGNA</b>   SPONGE PACKAGING		INDIFFERENZIATO   GENERAL WASTE
<b>NASTRO ADESIVO</b>   DUCT TAPE		INDIFFERENZIATO   GENERAL WASTE
<b>POLISTIROLO</b>   POLYSTYRENE		INDIFFERENZIATO   GENERAL WASTE
<b>SACCHETTO COTONE</b>   COTTON BAG		INDIFFERENZIATO   GENERAL WASTE
<b>SACCHETTO TNT</b>   TNT BAG		INDIFFERENZIATO   GENERAL WASTE

**\*verifica le disposizioni del tuo comune**  
\*check local regulations for proper disposal